



www.riso.co.za

RETHINK MONOPRINT



ComColor
black
FW1230

Rethink inkjet.

Experience the difference with this ultra-fast compact printer that really delivers.



ComColor black

The power of inkjet.

Ultimate speed and efficiency.

Inkjet printers require no heat when printing unlike laser printers. ComColor black FW1230 boasts ultra-fast print speed combined with a fast first print time to streamline printing, helping make busy work environments more efficient. Its ultimately low power consumption prevents paper from curling to reduce paper jams. And because output requires no cooling, pages can be sent immediately after printing to any of your optional finishers, vastly reducing production times.

Advancements all around

High productivity for any workplace.



With print speeds at 120 ppm, duplex scanning and a rich feature set, ComColor black FW1230 brings a new level of productivity to any workplace. You'll also appreciate its modest footprint — the ideal choice where space is at a premium. Affordable on-demand printing ensures smooth operation to increase efficiency.

Superb efficiency for high volume printing.



ComColor black FW1230 is the right choice for low-cost, high-speed printing. This cost-efficient, ultra-fast black and white printer can be used with a variety of optional post-printing accessories for a reliable in-house print solution. It also goes easy on the environment thanks to the energy-saving design.

Excellent usability for every work environment.



The easy to use and intuitive user interface of ComColor black FW1230 makes anyone a master of efficiency. Management and maintenance tasks are also simplified, ensuring speedy workflows and reduced downtime.

ck FW1230

High productivity for any workplace.



Ultra high-speed printing at 120 ppm

The amazingly fast print speed of 120 ppm in black and white allows ComColor black FW1230 to significantly quicken high-volume print jobs.

Print Time for 1,000 A4-size Sheets (A4/letter-size, long-edge feed simplex)

ComColor black FW 1230	Approx. 8 minutes
Typical office laser printer	25 minutes*

* At 40 ppm

Duplex printing shares this efficiency, reaching up to 120 ppm. Thanks to high-precision paper-feed control, ComColor black FW1230 prints at the same speed for both simplex and duplex documents to boost productivity. The responsive first print time of only 5 seconds means less waiting for both short print runs and high-volume jobs.

The optional one-pass duplex scanner drastically enhances processing speed for scanning. You can load up to 200 sheets for quick scanning and copying of large documents.



Compact design to fit any workplace

The compact print head and tray-free design make for a small footprint, allowing installation of ComColor black FW1230 almost anywhere.

Comparison with previous ComColor model

Cubic measurement
8% smaller

Footprint
11% smaller

Note: Approximate measurements



Two paper-feed trays are easily accessible and hold 500 sheets* each while the standard tray handles 1,000 sheets.* This equals a paper capacity of 2,000 sheets* in a slim body.



* When using plain paper or recycled paper (80 gsm (23-lb bond))

Reliability

The RISO inkjet advantage
Your assurance of quality and reliability

Instant-drying ink complements the high-speed, duplex printing capability. This specially developed, oil-based ink is also fade-resistant and water-resistant, and minimizes paper curling. Stable paper feeding ensures the reliable performance necessary for high-speed printing. Paper-feed speed is intelligently controlled according to how much ink is emitted from the print head. Also, multiple sensors help ensure high levels of reliability.

Durability

Tough body for reliable operation

High-speed, high-volume printing requires a durable body. ComColor black FW1230 is tough enough to print millions of sheets.

Dimensions

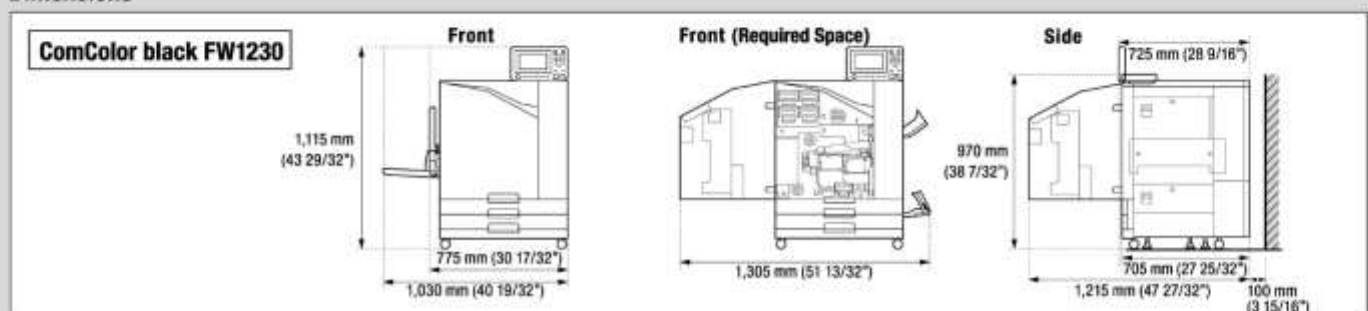

Superb efficiency for high volume printing.



Low-cost black and white printing

ComColor Standard — RISO's original color profile — accurately controls the amount of ink ejected from the print head depending on document type and media. This maintains image quality and optimizes ink usage, ultimately lowering operating costs. ComColor black FW1230 can handle a variety of tasks, including copying, printing and post-processing. This improves productivity while keeping costs down.

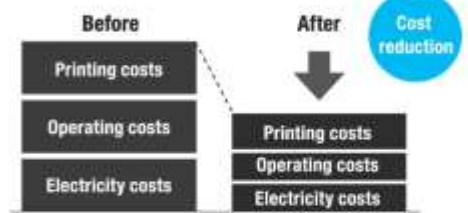

On-demand printing

White paper solution decreases waste, as it allows printing on-demand as and when required. ComColor black FW1230 also supports variable-data printing, eliminating the need for pre-printed stock. You can also add sequential numbers and barcodes. The fast print speed lets you make last-minute changes and print high-volume jobs within tight schedules. Furthermore, less reliance on outsourcing shortens turnaround time and gives you more control over document production.



Intelligent design for flexibility and efficiency

A simple paper-feed mechanism with no heating function supports a wide range of media, from plain paper and envelopes to cards. Paper is less likely to curl as no heat is applied during printing, thereby minimizing paper jams. This feature also ensures smooth pre- and post-processing. Production times for long print runs can be reduced by inserting slip sheets to facilitate sorting, adding covers and performing program printing.

RISO's Barcode Area Definition application automatically detects barcodes. Print density for barcode areas can be easily and quickly adjusted for optimal readability.

The energy-efficient printing process offers smooth, economical operation. Unlike toner-based printers, ComColor black FW1230 employs an imaging process that eliminates ozone and toner emissions.

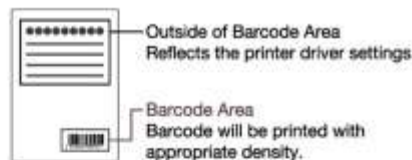

More energy-saving functions

Power schedule mode

This function allows you to automatically turn the power on and off at a specified time. Up to 10 sets of combinations of start or end times and days of the week can be registered. Never worry about forgetting to turn the printer off after working hours or over the weekend.

Sleep mode

Set when the printer enters sleep mode after the last print job to further decrease power consumption. This mode keeps power consumption to a miniscule 4W, further enhancing savings on electricity bills.

ECO-PROVEN PERFORMANCE WORLDWIDE

ComColor's acquisition of and compliance with various environmental labels and directives from around the world are your assurance of the green performance. The following labels and directives apply to the ComColor FW series.



www.blauer-engel.de/uz205

- low energy consumption
- low emissions and noise
- durable

The Blue Angel is the German government's label for environmentally friendly products and services. As the first environmental label worldwide, it has stood for independence and credibility for over 35 years as an eco-label you can trust. (ComColor black FW1230 has acquired the Blue Angel in Germany.)



ENERGY STAR® Program

An international program that promotes energy saving in office machines. This program is implemented in the United States, Canada, Japan, Switzerland, and Taiwan.

EPEAT

The definitive global rating system in the United States for greener electronics. EPEAT (Electronic Product Environmental Assessment Tool) combines comprehensive criteria with ongoing independent verification of manufacturer claims, across the broadest range of products and sectors. (ComColor black FW1230 is EPEAT Silver rating registered in the United States.)



Excellent usability for every work environment.



Designed for simple operation

An easy-to-view touch panel with instantly recognizable color icons makes printer operation simple for anyone. The tilt panel ensures excellent viewing at any angle up to 90 degrees, expanding installation flexibility. Scan preview windows show scanned images before saving data, ensuring less scan failures. For added convenience when printing and copying, frequently used functions can be saved as Favorites.



Expanded usability

The optional PS kit supports a variety of operating systems, and PDF files can be printed directly from USB flash drives, while RISO Print-S application allows printing from smart devices. ComColor black FW1230 offers reliable support for any work environment.



ComColor functions and output modes



Useful scanner functions

The optional Scanner HS7000 can save scanned data over the network to a PC, as an attachment to e-mail, or onto a hard disk of a networked RISO machine. Multi-page documents can be saved in PDF format as either separate files or combined into one file. Documents can be saved as PDF, TIFF, JPEG or PDF/A (suitable for long-term storage) formats.



Easy management for administrators

Up to 1,000 users can be registered. Connecting to an internal directory with LDAP authentication ensures quick configuration for a large number of users. The optional IC Card Authentication Kit enables user management using an IC card. Other maintenance tasks can be performed simply and speedily.



Optional accessories to customize your workflow

Face Down Finisher F10

Compact finisher exclusively for offset stacking and stapling finished prints.

Applicable Paper Size

Without offset

Maximum: 340 mm x 550 mm (13 3/8" x 21 5/8")
Minimum: 90 mm x 148 mm (3 9/16" x 5 27/32")

Offset output

Regular sized paper width: 182 mm x 257 mm - 297 mm x 431.8 mm
(7 3/16" x 10 1/8" - 11 13/16" x 17")
Irregular sized paper width: 131 mm x 148 mm - 306 mm x 550 mm
(5 3/16" x 5 27/32" - 12" x 21 5/8")

Paper Weight 40 gsm to 210 gsm (12-lb bond to 56-lb bond)

Tray Capacity Height up to 108 mm (4 1/4")

Maximum Number of Sheets for Staples

50 sheets* A4, B5-LHS, Letter

25 sheets* A3, B4-LHS, Ledger, Legal, Foolscap

Paper Weight for Staple 52 gsm to 210 gsm (14-lb bond to 56-lb bond)

Staple Position

1 at front side (angle stapling)

1 at rear side (angle stapling)

2 at center (parallel stapling)

Power Consumption Max. 100 W

Print Speed (long-edge feed, simplex)

Without offset 120 ppm

Offset output 105 ppm

* When using plain paper or recycled paper (85 gsm (23-lb bond))



Scanner HS7000

The auto feeder enables copying and scanning of duplex originals of up to 200 sheets¹⁾ at a time.

Copy Functions

Writing Resolution Standard: 600 dpi x 600 dpi

Copy Paper Size Maximum: 303 mm x 432 mm (11 15/16" x 17")

First Copy Time Monochrome: 7 sec or less²⁾

Copying Speed 70 ppm (Simplex/Duplex)³⁾

Scan Functions

Scanning Speed Monochrome/Color: 100 ppm⁴⁾

Network Interface Ethernet 100BASE-T/100BASE-TX/10BASE-T

Data-saving Format Monochrome: TIFF, PDF

Grayscale/Full Color: TIFF, JPEG, PDF

Power Consumption Max. 100 W

¹⁾ 60 gsm (21-lb bond) or less

²⁾ When copying A4/Letter long-edge feed, using Color Priority Mode

³⁾ When copying A4/Letter long-edge feed, using Auto Document Feeder

⁴⁾ RISO KAGAKU standard original, A4/Letter long-edge feed, 300 dpi, JPEG or PDF, when stored to main unit hard drive, using Auto Document Feeder

Multifunction Finisher FG10

Intelligent inline functions performed automatically simplify the finishing process.

Stapling Stapling options include: One corner staple or two staples for up to 100 sheets* of paper.

Punching Holes can be punched through documents. Choose two/three holes in the U.S., or two/four holes elsewhere.

Folding Various automatic folding options are available [inward, outward, for A3/Ledger-to-A4/Letter sheet footprint] reductions; and two-fold for up to five sheets making a 20-page booklet].

Booklet making Automatic saddle stitch stapling of up to 60 pages (15 sheets).

* When using plain paper or recycled paper (85 gsm (23-lb bond)) for A4, Letter, and B5



Folder Unit FG10

Folder Unit FG10 supports A4 tri-fold¹⁾. Mixed-size documents using A3-size and A4-size bundles by Z-folding the A3-size sheets²⁾.

¹⁾ Does not support tri-fold or Z-fold for multi-page documents.

²⁾ When using an application that supports mixed-size printing. Supports Ledger/Letter-size, A3/A4-size, and B4/B5-size combinations.

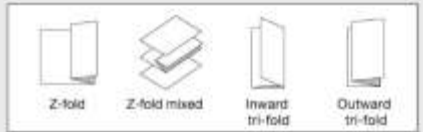
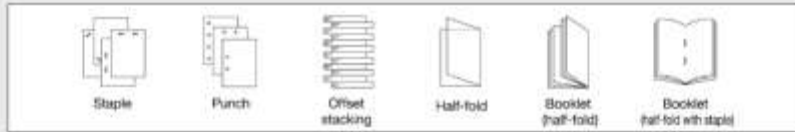

RISO Auto-Control Stacking Tray II

The paper guides automatically open to the correct width to match the paper in use.

Paper Size

Maximum: 320 mm x 432 mm (12 9/16" x 17")

Minimum: 90 mm x 148 mm (3 9/16" x 5 13/16")

Tray Capacity* 1,000 sheets

* When using plain paper or recycled paper (85 gsm (23-lb bond))



Wide Stacking Tray

Paper Size

Maximum: 340 mm x 550 mm (13 3/8" x 21 5/8")

Minimum: 90 mm x 148 mm (3 9/16" x 5 13/16")

Tray Capacity* 1,000 sheets

* When using plain paper or recycled paper (85 gsm (23-lb bond))



ComColorExpress RS1100C

RIP software that supports the functions and workflows essential for transactional printing, bringing high productivity to every business environment.

PS Kit FG10

PS kit supports a variety of operating systems, and PDF files can be printed directly from USB flash drives.

Consumables

ComColor FW Ink Cartridge

Replenishing ink is clean and easy with slim ink cartridges and the ComColor's clever design.

Color: Black



HC Staple 100

Staples for the Multifunction Finisher FG10.

Unit: 15,000 pieces of staples per carton box.



HC Staple Booklet

Saddle stitch staples for the Multifunction Finisher FG10.

Unit: 20,000 pieces of staples per carton box.



ComColor Staple 50(G)

Staples for the Face Down Finisher F10.

Unit: 15,000 pieces of staples per carton box.



Dimensions

ComColor black FW1230 + Scanner HS7000 + Face Down Finisher F10

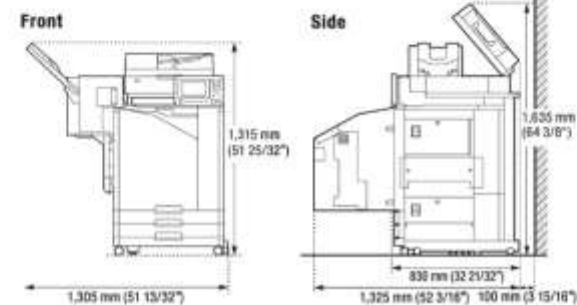

ComColor black FW1230 + Scanner HS7000 + Multifunction Finisher FG10 + Folder Unit FG10

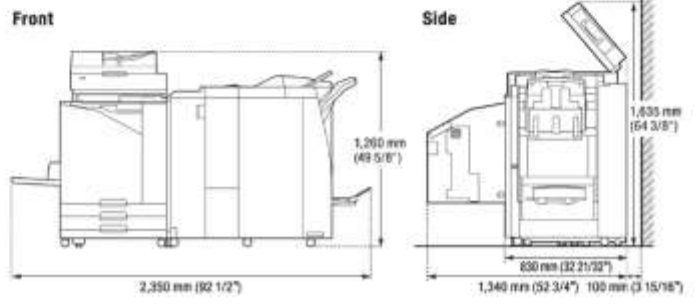

Specifications

Print Type	Line-type inkjet system	
Ink Type	Oil-based pigment ink (Black)	
Print Resolution	Standard: 600 dpi (main scanning direction) × 600 dpi (sub-scanning direction)	
Number of Gray Levels	For K color (3 gray levels)	
Data Processing Resolution	Standard: 600 dpi × 600 dpi	
Warm-up Time	2 min, 30 sec. or less (at room temperature of 23°C (73.4°F))	
First Print Time*1	5 sec. or less (A4 long-edge feed)	
First Copy Time**	7 sec. or less (A4 long-edge feed)	
Continuous Print Speed**4	A4 long-edge feed	Simplex: 120 ppm Duplex: 60 sheets/minute (120 ppm)
	Letter long-edge feed	Simplex: 120 ppm Duplex: 60 sheets/minute (120 ppm)
	A4 short-edge feed	Simplex: 90 ppm Duplex: 45 sheets/minute (90 ppm)
	Letter short-edge feed	Simplex: 90 ppm Duplex: 45 sheets/minute (90 ppm)
	B4 (JIS) short-edge feed	Simplex: 76 ppm Duplex: 34 sheets/minute (68 ppm)
	Legal short-edge feed	Simplex: 76 ppm Duplex: 34 sheets/minute (68 ppm)
	A3 short-edge feed	Simplex: 66 ppm Duplex: 32 sheets/minute (64 ppm)
Paper Size	Standard Tray	Maximum: 340 mm × 550 mm (13 3/8" × 21 5/8")*10 Minimum: 90 mm × 148 mm (3 9/16" × 5 27/32")
	Feed Tray	Maximum: 297 mm × 432 mm (11 11/16" × 17") Minimum: 182 mm × 182 mm (7 3/16" × 7 3/16")
Printable Area	Maximum: 310 mm × 544 mm (12 3/16" × 21 13/32")	
Guaranteed Print Area**	Standard	Margin width of 5 mm (7/32")
	Maximum	Margin width of 3 mm (1/8")
Paper Weight	Standard Tray	Simplex: 46 gsm to 210 gsm (12-lb bond to 56-lb bond) Duplex: 46 gsm to 210 gsm (12-lb bond to 56-lb bond) for A4 and Letter 46 gsm to 104 gsm (12-lb bond to 28-lb bond) for Ledger, A3, Legal, and B4
	Feed Tray	Simplex: 52 gsm to 104 gsm (14-lb bond to 28-lb bond) Duplex: 52 gsm to 104 gsm (14-lb bond to 28-lb bond)
Paper Tray Capacity	Standard Tray	Height up to 110 mm (4 5/16")
	Feed Tray	Height up to 56 mm (2 3/16") (× 2 trays)
Output Tray Capacity	Height up to 56 mm (2 3/16")	
PDL (Page Description Language)	RISORINC/C IV	
Supported Protocols	TCP/IP, HTTP, HTTPS (TLS), DHCP, ftp, lpr, IPP, SNMP, Port 9100 (RAW port), IPv4, IPv6, IPsec	
Supported Operating Systems	Standard	Microsoft®: Windows® 7 (32-bit/64-bit), Windows 8.1 (32-bit/64-bit), Windows 10 (32-bit/64-bit), Windows Server® 2008 (32-bit/64-bit), Windows Server 2008 R2 (64-bit), Windows Server 2012 (64-bit), Windows Server 2012 R2 (64-bit), Windows Server 2016 (64-bit)
	Optional**5	Mac: Mac OS v10.8 (Mountain Lion), v10.9 (Mavericks), v10.10 (Yosemite), v10.11 (El Capitan), v10.12 (Sierra), v10.13 (High Sierra), v10.14 (Mojave) Linux® (compatible with PPD only)
Network Interface	Ethernet 1000BASE-T, 100BASE-TX, 10BASE-T	
Memory Capacity	4 GB	
Hard Disk**	Capacity	500 GB
	Available Space	Approx. 430 GB
Operating System	Linux	
Power Source	AC 100-240 V, 10.0-5.0 A, 50-60 Hz	
Power Consumption	Max.	1,000 W
	Ready**7:	150 W or less
	Sleep**8:	2 W or less
	Stand-by:	0.4 W or less
Operating Noise	Max. 65 dB (A) A4 long-edge feed (Simplex) at the maximum print speed	
Operating Environment	Temperature: 15°C to 30°C (59°F to 86°F) Humidity: 40% to 70% RH (non-condensing)	
Dimensions (W × D × H)	In use: 1,030 mm × 725 mm × 1,115 mm (40 19/32" × 28 9/16" × 43 29/32") With cover and tray closed: 775 mm × 705 mm × 970 mm (30 17/32" × 27 25/32" × 38 7/32")	
Weight	Approx. 132 kg (292 lb)	
Required Space (W × D × H)**	1,305 mm × 1,215 mm × 1,115 mm (51 13/32" × 47 27/32" × 43 29/32")	

Specifications are subject to change without notice.

*1 Within 10 minutes after the last print job. *2 When using plain paper or recycled paper (85 gsm (23-lb bond)), and density setting (Standard) 3 (Standard) Chart used; Print measurement pattern (Color measurement sample 2 (JEITA standard pattern J6)). *3 The continuous print speed varies depending on the type of optional output equipment connected. *4 The margin when printing envelopes is 10 mm (3/8"). The guaranteed area when printing images is the area enclosed within 5 mm (7/32") of the edges of the paper. *5 Optional PS kit is required. *6 One gigabyte (GB) is calculated as 1 billion bytes. *7 Without printing and temperature adjustment operation. *8 When setting (Power Consumption (in sleep)) to [Low]. *9 With the front cover open and the operation panel in the upright position. *10 When using duplex print: 340 mm × 490 mm (13 3/8" × 19 3/32").

® RISO, and ComColor, FORCEJET and RISORINC are trademarks or registered trademarks of RISO KAGAKU CORPORATION. PostScript is either registered trademarks or trademarks of Adobe Systems Incorporated in the United States and/or other countries. Mac is trademark of Apple Inc. Microsoft, Windows and Windows Server are either registered trademarks or trademarks of Microsoft Corporation in the United States and/or other countries. Linux® is the registered trademark of Linus Torvalds in the U.S. and other countries. Other corporate names and/or trademarks are either registered trademarks or trademarks of each company, respectively.

For more details please contact: